

wagraf®

OD 1957 ROKU

KATALOG PRODUKTÓW

2015



wagraf®

OD 1957 ROKU

**ZAWSZE
NA CZASIE**



wagraf®

Automaty samotuszujące POLAN WAGRAF, PIAST e-3	2
Tuszownice wymienne	5
Automaty samotuszujące okrągłe Fi 30 i 40 datownik Fi D40	6
Datowniki automatyczne plastikowe szkieletowe	8
Automaty samotuszujące plastikowe szkieletowe	9
Automaty samotuszujące metalowe HUZAR	10
Pudełka metalowe	12
Pudełka plastikowe	13
Datowniki automatyczne plastikowe DATUŚ POLAN	15
Datowniki automatyczne metalowe WAGRAF HUZAR	16
Uchwyty plastikowe do stempli	17
Poduszki	19
Materiały eksploatacyjne do stempli polimerowych i laserowych	20
Pieczałka w 5 minut – stempel preink automaty samotuszujące pudełka plastikowe	22
Materiały eksploatacyjne do stempli preink	24
Maszyny do naświetlania	25

wagraf®

Automaty samotuszujące

POLAN

POLAN 1s	Compact	28x10mm
POLAN 2		39x15mm
POLAN 2s	Compact	39x15mm
POLAN 3		48x19mm
POLAN 3s	Compact	48x19mm
POLAN 4		59x25mm
POLAN 4s	Compact	59x25mm



POLAN 1s

28x10mm



POLAN 2



POLAN 2s

39x15mm



POLAN 3



POLAN 3s

48x19mm



POLAN 4



POLAN 4s

59x25mm

POLAN

POLAN 5		70x26mm
POLAN 5s	Compact	70x26mm
POLAN 55		42x34mm
POLAN 6		69x29mm
POLAN 6s	Compact	69x29mm
POLAN 7		60x40mm
POLAN 8		75x40mm



POLAN 5



POLAN 5s

NOWOŚĆ

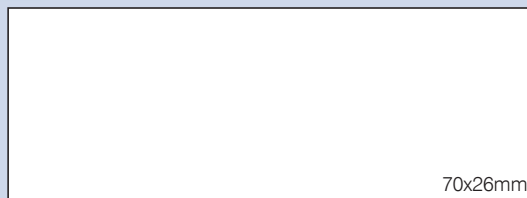

70x26mm



POLAN 55

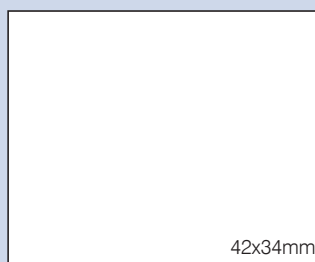

42x34mm



POLAN 6



POLAN 6s

NOWOŚĆ

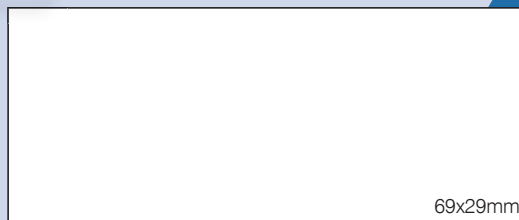

69x29mm



POLAN 7

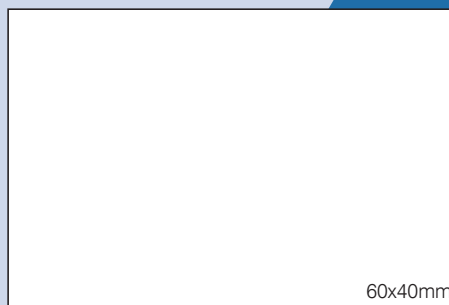

60x40mm



POLAN 8

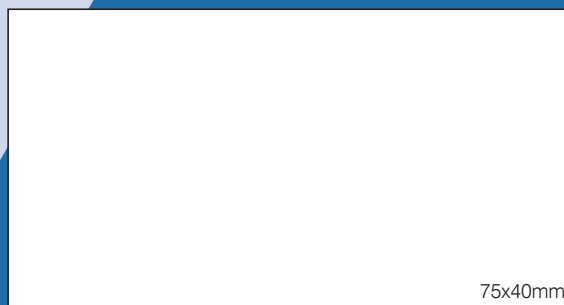

75x40mm

duża pieczęćka

wagraf®

Automaty samotuszujące

WAGRAF

WAGRAF 1s	Compact	28x10mm
WAGRAF 2		38x14mm
WAGRAF 2s	Compact	38x14mm
WAGRAF 3		47x18mm
WAGRAF 3s	Compact	47x18mm
WAGRAF 4		58x22mm
WAGRAF 4s	Compact	58x22mm



WAGRAF 1s



28x10mm



WAGRAF 2



WAGRAF 2s

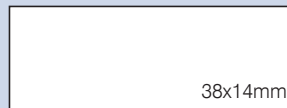

38x14mm



WAGRAF 3



WAGRAF 3s

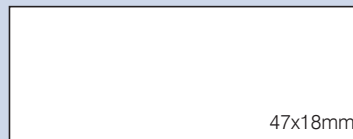

47x18mm



WAGRAF 4



WAGRAF 4s

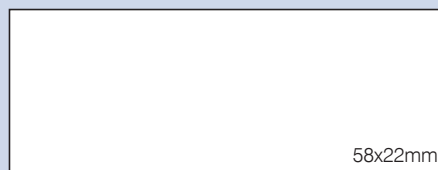

58x22mm

PIAST e-3



PIAST e-3



PIAST e-3s

PIAST e-3		50x25mm
PIAST e-3s	Compact	50x25mm

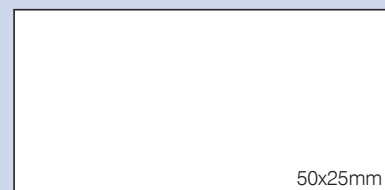

50x25mm

Tuszownice wymienne

TUSZOWNICE NASĄCZONE

tuszem w kolorach: czarny, czerwony, niebieski, zielony, fioletowy

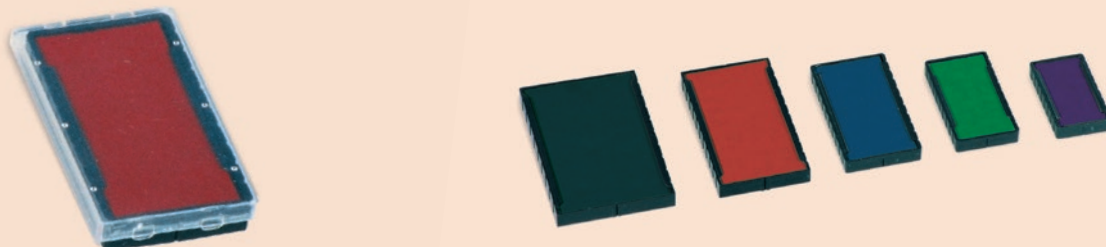

Istnieje możliwość zastosowania innego koloru tuszu do odbijania tekstu z płytki i innego do daty w datownikach POLAN D55, POLAN D7, WAGRAF D230 i D240

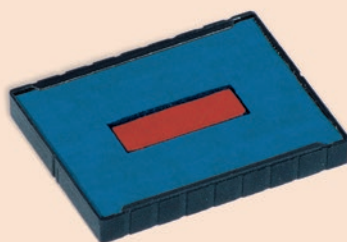

Do automatów Fi 30 i Fi 40 dostępne są tuszownice nasączone i nienasączone.

TUSZOWNICE NIENASĄCZONE

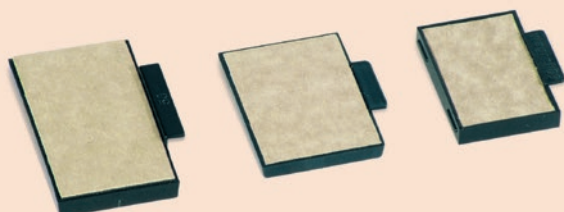

1	WAGRAF 1	28x10mm	■ ■ ■ ■ ■
2	POLAN 1 DATUŚ	30x12mm	■ ■ ■ ■ ■
3	WAGRAF 2 POLAN 2	38x14mm	■ ■ ■ ■ ■
4	WAGRAF 3 POLAN 3	47x18mm	■ ■ ■ ■ ■
5	PIAST e-3	50x25mm	■ ■ ■ ■ ■
6	WAGRAF 4 POLAN 4	58x22mm	■ ■ ■ ■ ■
7	POLAN 5	70x26mm	■ ■ ■ ■ ■
8	POLAN 55 POLAN D55	42x34mm	■ ■ ■ ■ ■
9	POLAN 6	69x29mm	■ ■ ■ ■ ■
10	POLAN 7 POLAN D7	60x40mm	■ ■ ■ ■ ■
11	POLAN 8	75x40mm	■ ■ ■ ■ ■
12	Fi 30	Ø 30mm	■ ■ ■ ■ ■
13	Fi 40	Ø 40mm	■ ■ ■ ■ ■
14	WAGRAF D230 WAGRAF 230	43x35mm	■ ■ ■ ■ ■
15	WAGRAF D240 WAGRAF 240	60x40mm	■ ■ ■ ■ ■
16	HUZAR 20	39x14mm	■ ■ ■ ■ ■
17	HUZAR 30 HUZAR D 30	42x30mm	■ ■ ■ ■ ■
18	HUZAR 40	55x23mm	■ ■ ■ ■ ■
19	HUZAR 50	58x30mm	■ ■ ■ ■ ■
20	HUZAR 60	70x24mm	■ ■ ■ ■ ■
21	HUZAR 80 HUZAR D80	70x48mm	■ ■ ■ ■ ■
22	WAGRAF 100	25x42mm	■ ■ ■ ■ ■
23	WAGRAF 140	40x60mm	■ ■ ■ ■ ■

paleta barw

wagraf®

Automaty stemplarskie okrągłe *fi 30, fi 40*



Fi 30

Ø 30mm

NOWOŚĆ



Fi 40

Ø 40mm



Datownik automatyczny plastikowy okrągły *fi* D40

NOWOŚĆ

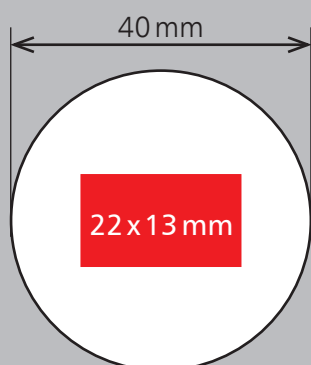

Fi 40



datuj na okrągło

Datowniki automatyczne plastikowe szkieletowe

NOWOŚĆ



WAGRAF D 230

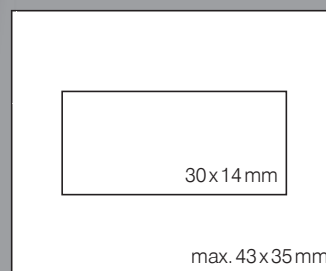

W datownikach automatycznych plastikowych szkieletowych D230 i D240 elementy plastikowe występują w 9 różnych kolorach



Datowniki automatyczne plastikowe szkieletowe pozwalają na zamieszczenie w odbiciu pieczętki

- daty
- oraz tekstu dowolnej treści.

Istnieje możliwość zastosowania innego koloru tuszu do odbijania tekstu z płytki i innego do daty.

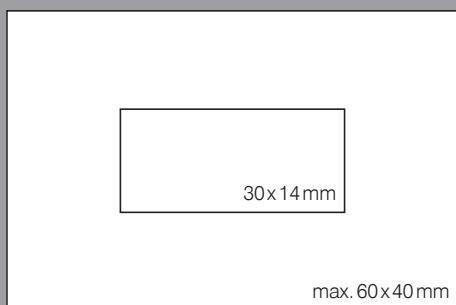

WAGRAF D 240



Automaty samotuszujące plastikowe szkieletowe

NOWOŚĆ



WAGRAF 230



max. 43x35mm

W automatach samotuszujących plastikowych szkieletowych D230 i D240 elementy plastikowe występują w 9 różnych kolorach

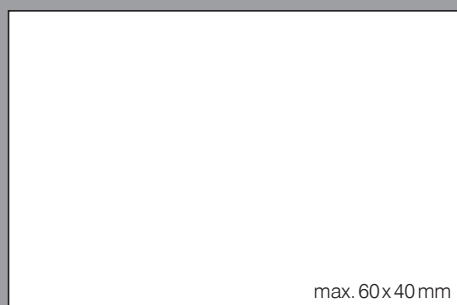

max. 60x40mm

WAGRAF 240



lekkie stemplowanie

wagraf®

Automaty samotuszujące metalowe

huzar®



huzar®

39x14mm

HUZAR 20

huzar®

42x30mm

HUZAR 30

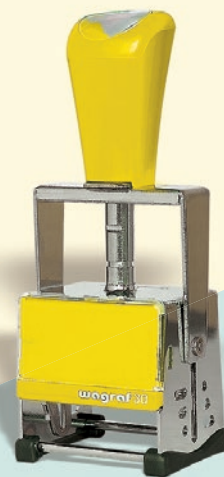

huzar®

55x23mm

HUZAR 40



huzar®

58x30mm

HUZAR 50

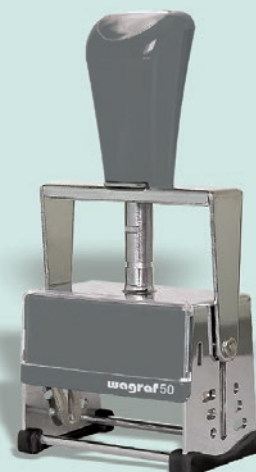

Huzar® to najnowszy model stempla ręcznego, zgłoszony do ochrony w Urzędzie Patentowym Rzeczypospolitej Polskiej Nr P-368177 i chroniony w krajach Unii Europejskiej i USA z ważnością od dnia 24.05.2004.



HUZAR 60

huzar®



70x24mm



HUZAR 65

huzar®

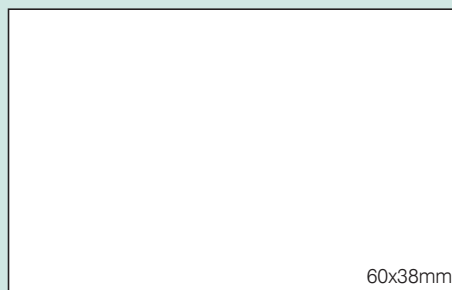

60x38mm



HUZAR 80

huzar®



70x48mm

HUZAR 20	metalowy	39x14mm
HUZAR 30	metalowy	42x30mm
HUZAR 40	metalowy	55x23mm
HUZAR 50	metalowy	58x30mm
HUZAR 60	metalowy	70x24mm
HUZAR 65	metalowy	60x38mm
HUZAR 80	metalowy	70x48mm

solidne stemplowanie

Pudełka metalowe

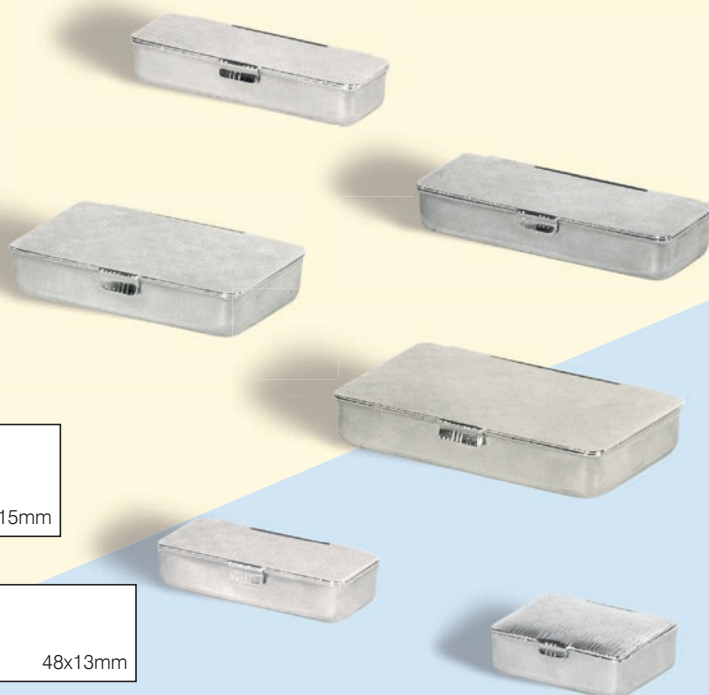

pudełko	nr 1	38x15mm
pudełko	nr 1,5	48x13mm
pudełko	nr 1 3/4	38x20mm
pudełko	nr 2 I	48x17mm
pudełko	nr 2 II	46x18mm
pudełko	nr 2,5	48x20mm
pudełko	nr 2 3/4 I	48x23mm
pudełko	nr 2 3/4 II	50x28mm
pudełko	nr 3	58x19mm
pudełko	nr 3,5	58x23mm
pudełko	nr 4	58x26mm
pudełko	nr 4,5	60x34mm
pudełko	nr 5	50x50mm
pudełko	nr 0	26x23mm
pudełko	nr 01	31x31mm

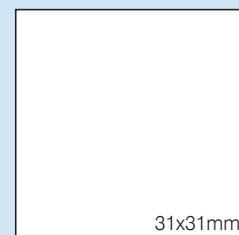
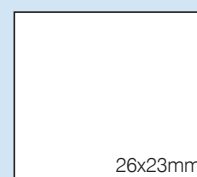
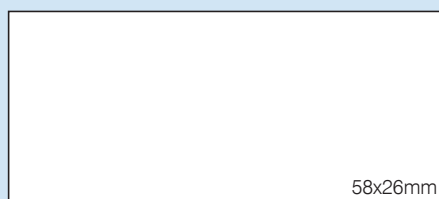
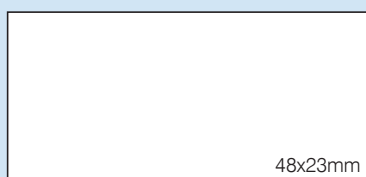
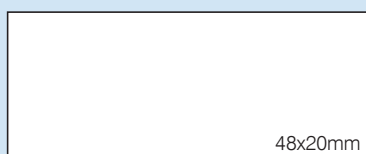
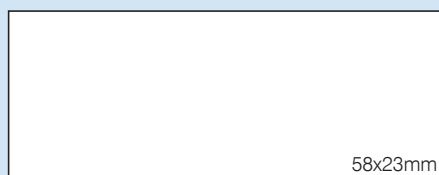
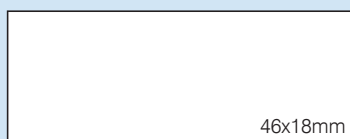
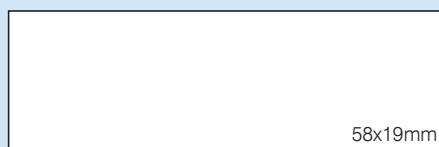
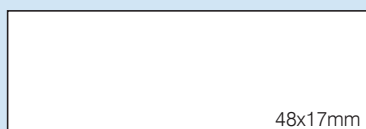
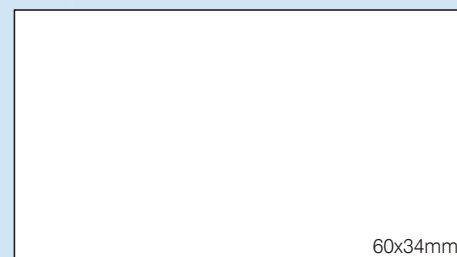
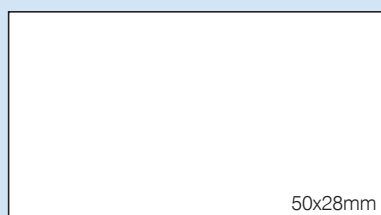
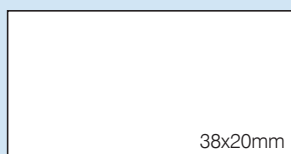
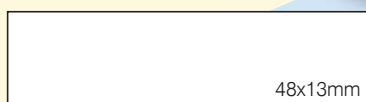
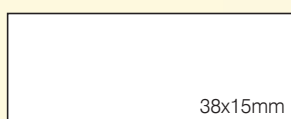



METAL BOX	nr 1	38x14mm
METAL BOX	nr 2	38x18mm
METAL BOX	nr 3	47x14mm
METAL BOX	nr 4	47x18mm
METAL BOX	nr 5	47x22mm
METAL BOX	nr 6	55x18mm
METAL BOX	nr 7	55x22mm

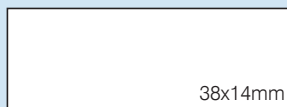

38x14mm

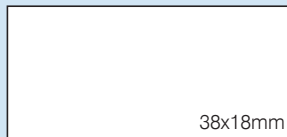

38x18mm



47x14mm

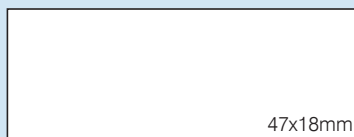

47x18mm

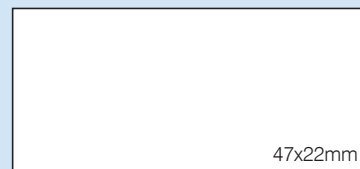

47x22mm

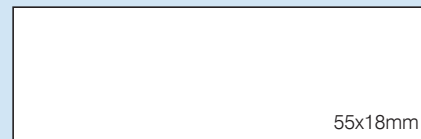

55x18mm

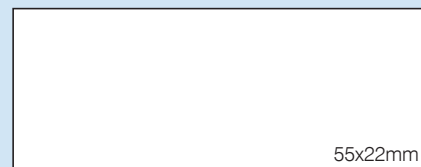

55x22mm

Pudełka plastikowe

PUDEŁKO nr 21

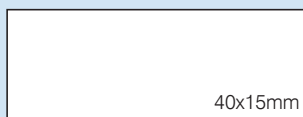

40x15mm

PUDEŁKO nr 22

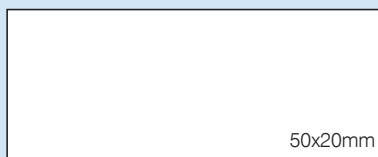

50x20mm

PUDEŁKO nr 23

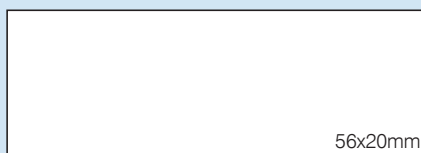

56x20mm

Pudełko	nr 21	40x15mm
Pudełko	nr 22	50x20mm
Pudełko	nr 23	56x20mm
Pudełko	nr 27	40x15mm
Pudełko	nr 28	50x20mm
Pudełko	nr 29	58x22mm

PUDEŁKO nr 27

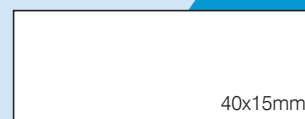

40x15mm

PUDEŁKO nr 28



50x20mm

PUDEŁKO nr 29

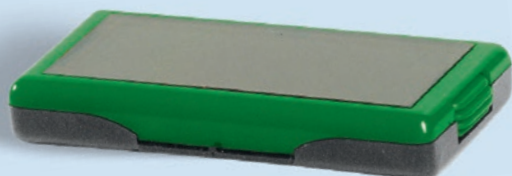

58x22mm

Pudełka plastikowe

NOWOŚĆ



Pudełko	nr 33	40x15mm
Pudełko	nr 34	50x20mm
Pudełko	nr 35	58x22mm

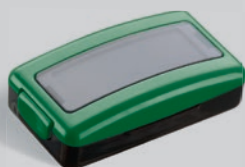

PUDEŁKO nr 33

40x15mm



PUDEŁKO nr 34

49x19mm



PUDEŁKO nr 35

60x23mm

stempel jak na dłoni

Datowniki automatyczne plastikowe

DATUŚ	bez płytki	
POLAN D 55		42x34mm
POLAN D 7		60x40mm

Datowniki automatyczne plastikowe pozwalają na zamieszczenie w odbiciu pieczętki

- daty
- oraz tekstu dowolnej treści.

Istnieje możliwość zastosowania innego koloru tuszu do odbijania tekstu z płytki i innego do daty.

DATUŚ bez płytki



POLAN D 55



POLAN D 7

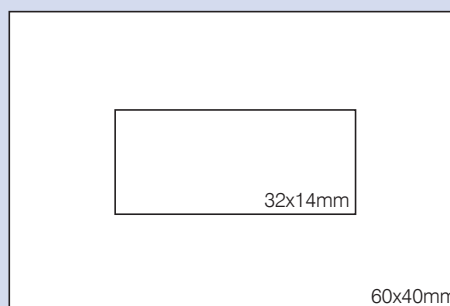
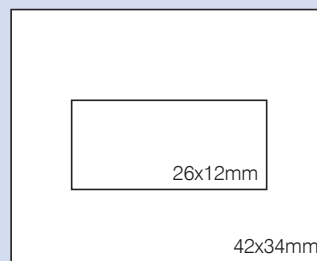

Datowniki automatyczne plastikowe szare i czarne – miesiące pisane słownie
2011 MAR. 14

Datowniki automatyczne plastikowe czerwone i granatowe – miesiące pisane cyframi
2011 -03- 14

Datowniki automatyczne metalowe



WAGRAF 110
bez płytki

WAGRAF 100		42x25mm
WAGRAF 110	bez płytki	
HUZAR 140		60x40mm
HUZAR D 30		42x30mm
HUZAR D 80		70x48mm



WAGRAF 100

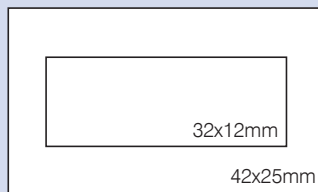

HUZAR 140

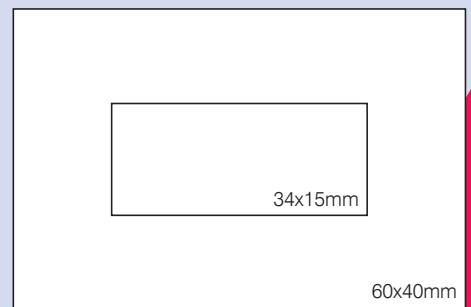

huzar®



HUZAR D 30

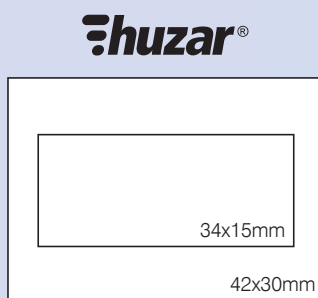

huzar®

Datowniki automatyczne metalowe pozwalają na zamieszczenie w odbiciu pieczętki

- daty
- oraz tekstu dowolnej treści.



HUZAR D 80

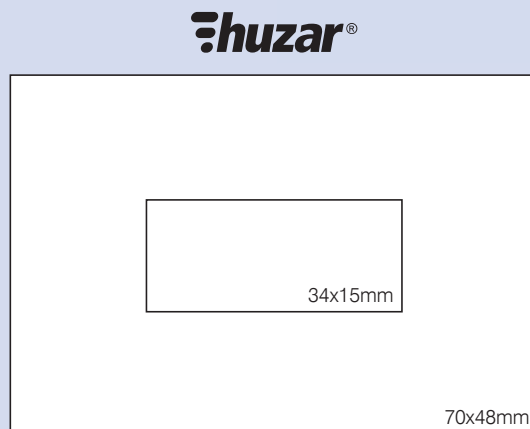

huzar®

+ tekst



Uchwyty plastikowe do stempli



13x50mm



15x40mm



20x40mm



17x50mm

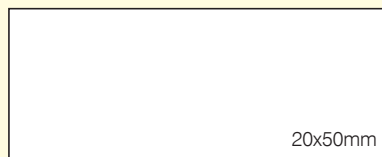

20x50mm

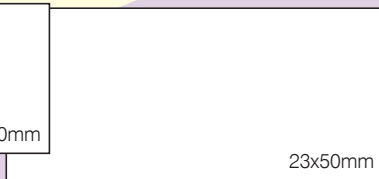

23x50mm

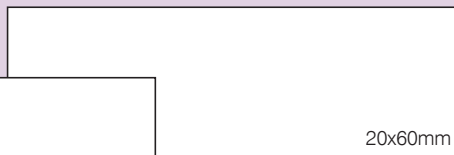

20x60mm

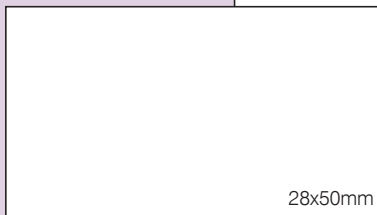

28x50mm



23x60mm

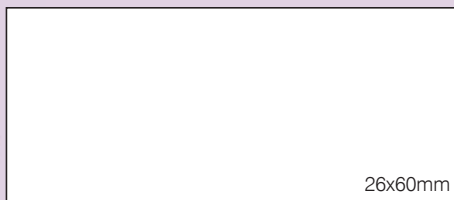

26x60mm

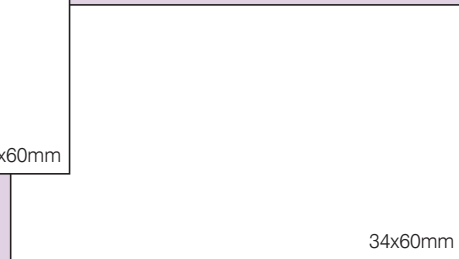

34x60mm



18x27mm

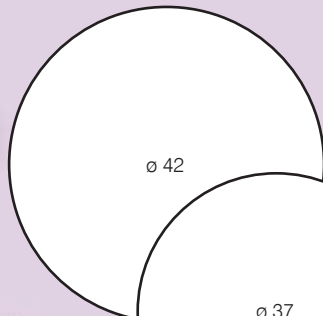

ø 42

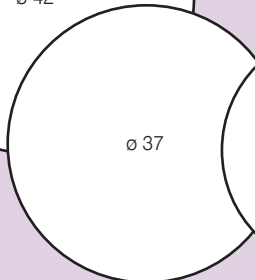

ø 37

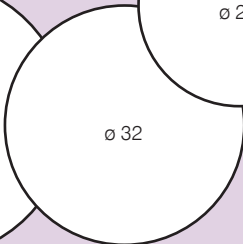

ø 32

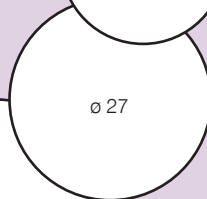

ø 27

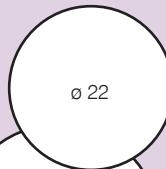

ø 22



Uchwyt	nr 1	15x40mm
Uchwyt	nr 1,5	13x50mm
Uchwyt	nr 1 3/4	20x40mm
Uchwyt	nr 2	17x50mm
Uchwyt	nr 2,5	20x50mm
Uchwyt	nr 2 3/4	23x50mm
Uchwyt	nr 2 3/4 II	28x50mm
Uchwyt	nr 3	20x60mm
Uchwyt	nr 3,5	23x60mm
Uchwyt	nr 4	26x60mm
Uchwyt	nr 4,5	34x60mm
Uchwyt	nr 0	18x27mm
Uchwyt	nr 740	7x40mm
Uchwyt	nr 745	7x45mm
Uchwyt	nr 750	7x50mm
Uchwyt	nr 755	7x55mm
Uchwyt	okrągły	ø 22
Uchwyt	okrągły	ø 27
Uchwyt	okrągły	ø 32
Uchwyt	okrągły	ø 37
Uchwyt	okrągły	ø 42
Uchwyt	nr 1040	10x40mm
Uchwyt	nr 1045	10x45mm
Uchwyt	nr 1055	10x55mm
Uchwyt	nr 1070	10x70mm



7x40mm



7x45mm



7x50mm



7x55mm



10x40mm



10x45mm



10x55mm



10x70mm

Uchwyt	nr 4075	40x75mm
Uchwyt	nr 4565	45x65mm
Uchwyt	nr 5555	55x55mm
Uchwyt	nr 5565	55x65mm
Uchwyt	nr 5575	55x75mm
Uchwyt	nr 6565	65x65mm

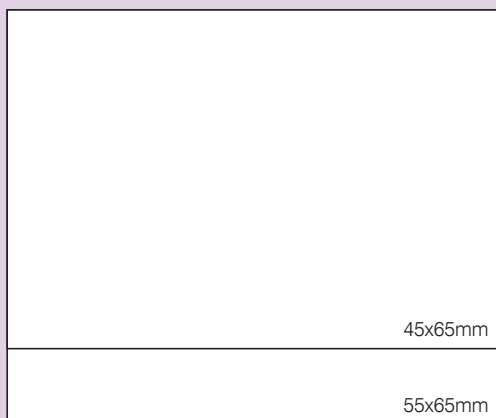
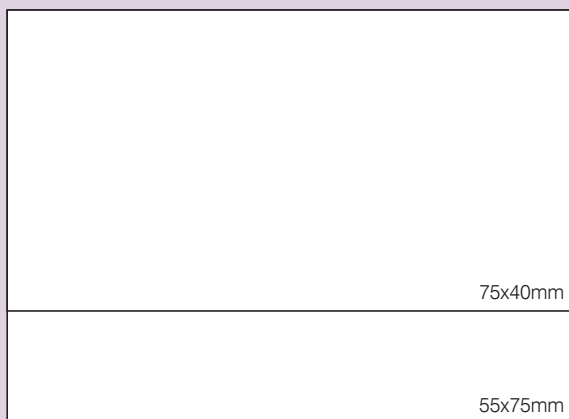

Uchwyt	nr 7090	70x90mm
Uchwyt	nr 80100	80x100mm
Uchwyt	nr 90110	90x110mm

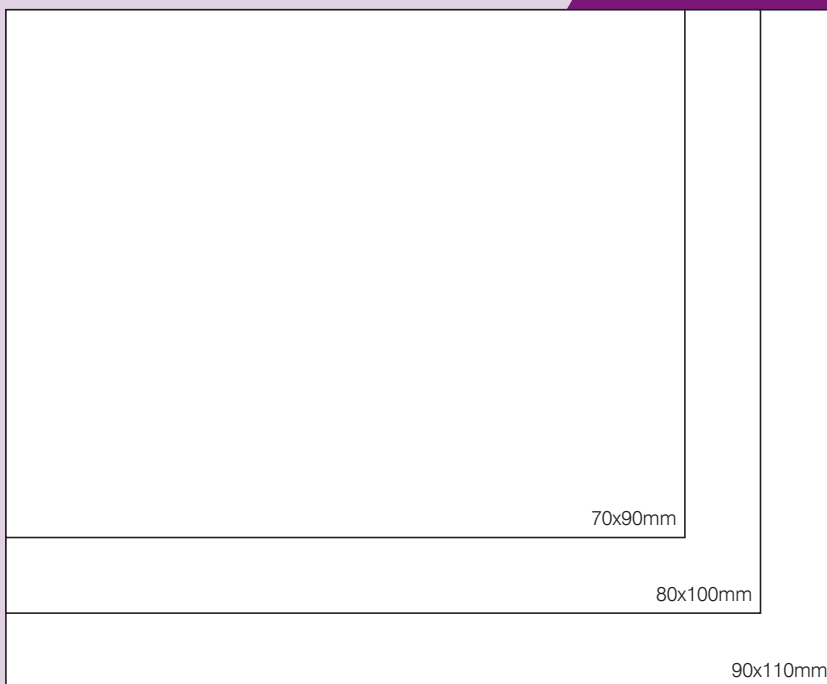
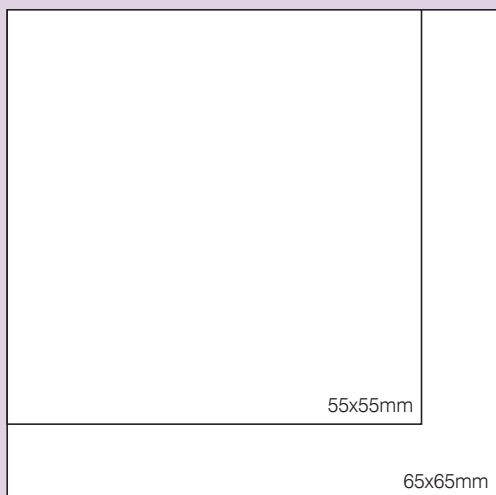

Poduszki



PM
poduszka mała (plastikowa) – 50 x 85 mm

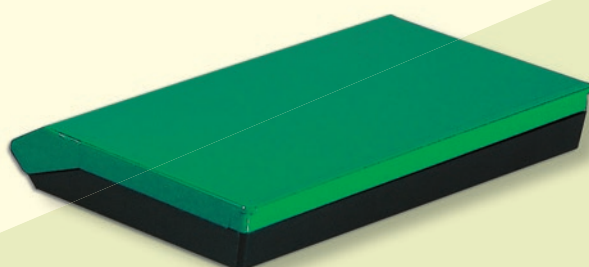

PS
poduszka średnia (plastikowa) – 70 x 110 mm

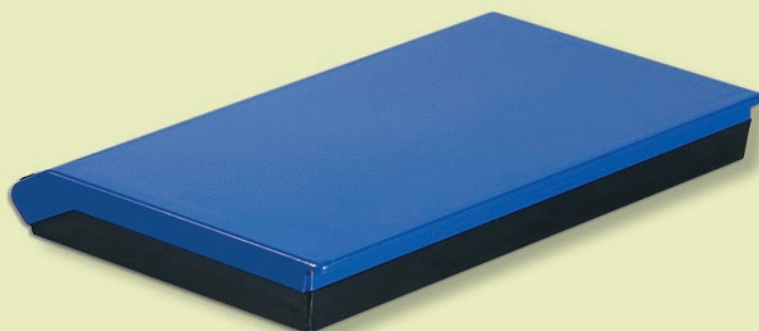

PD
poduszka duża (plastikowa) – 85 x 155 mm



PMD
poduszka metalowa duża – 190 x 110 mm

Poduszki plastikowe
PD, PS, PM
są nasączone tuszem.

Kolor pokrywki określa
kolor tuszu (czarny, niebieski,
czerwony, fioletowy, zielony).



Materiały eksploatacyjne do stempli polimerowych i laserowych



Fotopolimer 1 kg



Wywlocznik 1 kg



Utrwalacz 1 kg



Płyn do płukania 1 kg



Folia nośna



Folia ochronna



Kalka do wydruku, laser film



Film UV



Uszczelka (grubość 2 i 3 mm)



Tusz polimerowy 25 ml

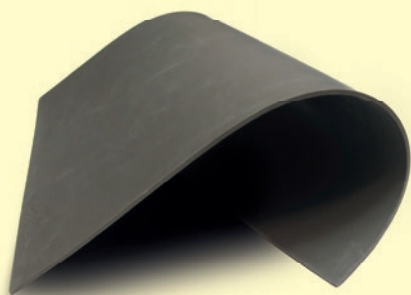

Guma do lasera

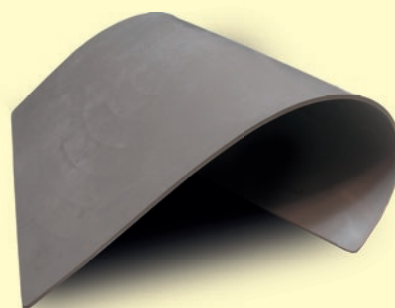

Guma do lasera ekonomiczna

Pieczętka w 5 minut Stempel preink

automaty samotuszujące

Do automatów a2, a3 i a4
dostępne są odpowiednie
materiały do naświetlania.



WAGRAF a2

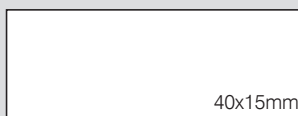

40x15mm



WAGRAF a3

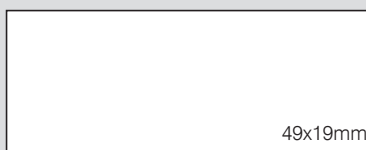

49x19mm



WAGRAF a4

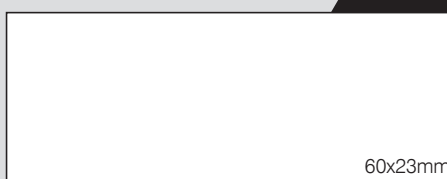

60x23mm

WAGRAF a2	preink	40x15mm
WAGRAF a3	preink	49x19mm
WAGRAF a4	preink	60x23mm



w 5 minut

Stempel preink pudełka plastikowe



PUDEŁKO nr 30	preink	40x15mm
PUDEŁKO nr 31	preink	49x19mm
PUDEŁKO nr 32	preink	60x23mm

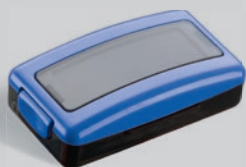

PUDEŁKO nr 30

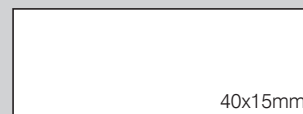

PUDEŁKO nr 31

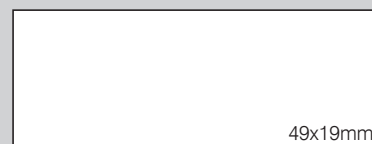

PUDEŁKO nr 32

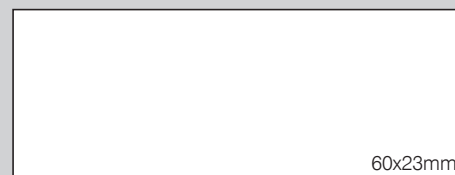

Do pudełek nr 30, 31 i 32
dostępne są odpowiednie
materiały do naświetlania.

Materiały eksploatacyjne do stempli preink



Kalka do wydruku, laser film



Folia ochronna

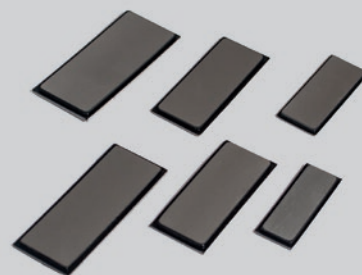

Materiał do naświetlania



Tusz do stempli w butelkach 30ml



Cartridge kolorowe do stempli

WAGRAF a2 PUDEŁKO nr 30	preink	40x15mm
WAGRAF a3 PUDEŁKO nr 31	preink	49x19mm
WAGRAF a4 PUDEŁKO nr 32	preink	60x23mm

Maszyny do naświetlania do stempli preink



MQ B1308 1 lampa



MQ B1409



MQ B1511

waggraf®



 DOŁĄCZ DO NAS

PL EN

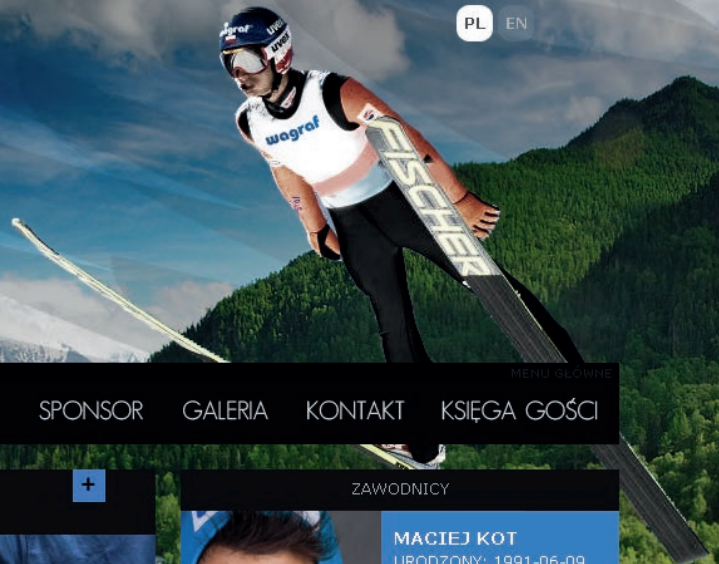

MENU GŁÓWNE

[GŁÓWNA](#) [O DRUŻYNIE](#) [ZAWODNICY](#) [WYNIKI](#) [SPONSOR](#) [GALERIA](#) [KONTAKT](#) [KSIĘGA GOŚCI](#)

2015-09-15
LPK w Stams: Maciek dwa razy drugi!



Dwukrotnie na drugim stopniu podium stanął Maciek podczas minionego weekendu skoków, które odbyły się w Stams w ramach Letniego Pucharu Kontynentalnego. Maciek imponował podczas soboty i niedzieli regularnością, bo w ścisłej czołówce był nie tylko w zawodach, ale i seriach treningowych oraz próbnych. Co do konkursów, to od Macka lepszy był tylko Norweg Tande, który dwukrotnie stanął na pierwszym stopniu podium. Spośród pozostałych zawodników Waggraf Teamu w zawodach startował także Bartek Klusek, który pierwszego dnia był 20., a drugiego 50. Kolejny weekend zawodów PK odbędzie się w Oslo i - jak wiemy - tam także wystartują nasi zawodnicy.

WIĘCEJ

2015-07-20
LMP: Maciek Kot z brązowym medalem!

2015-07-16
Już w sobotę Mistrzostwa Polski w Wiśle

2015-07-01
Pierwsze zawody PK już w ten weekend!

2015-05-22
Kadra na pierwszym zgrupowaniu w Cetniewie

archiwum

ZAWODNICY



MACIEJ KOT
URODZONY: 1991-06-09
WAGA: 59.5 kg
WZROST: 178 cm
ZAMIESZKAŁY: Zakopane
KLUB: AZS Zakopane
PSEUDONIM: Maniek,
Skarb, Kotek

DAJ SIĘ
ZASKOCZYĆ

POZNAJ SKOCZKÓW
I SPEŁNIJ MARZENIA



O SKAKANIU NIE CAŁKIEM OFICJALNIE - SKOCZ NA FBI!

PARTNERZY

waggraf

Waggraf

NASTĘPNE ZAWODY



BRAK ZAWODÓW W
NAJBLIŻSZYM
CZASIE

www.waggrafteam.pl



Zakład Mechaniczny

wagraf[®]

04-608 Warszawa - Anin, ul. Stradomska 56A
tel./fax 22 812 12 34, 22 815 62 83, 22 815 33 01, 22 815 63 05
www.wagraf.pl

